

产品应用

本系列片式产品需安装在合适的散热器上, 可用于功率分配网络中的终端负载和平衡电阻. 薄膜电阻技术和激光调阻技术保证了产品在大功率下的可靠性及产品精度等性能. 其氮化铝基板和无铅工艺可用于那些对氧化铍材料有限制或需符合欧盟 RoHS指令的地方.

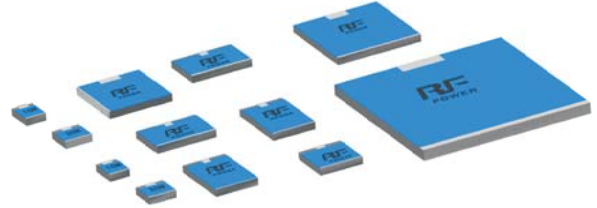

产品订货编号

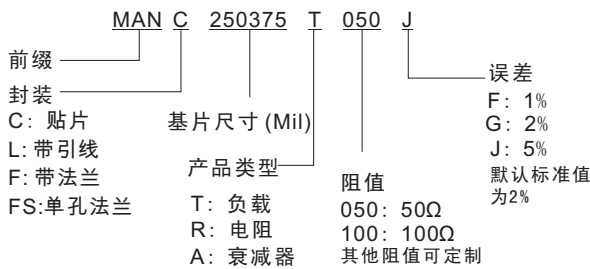

基本参数

焊盘	银
基板	氮化铝 (ALN)
电阻膜	薄膜

尺寸

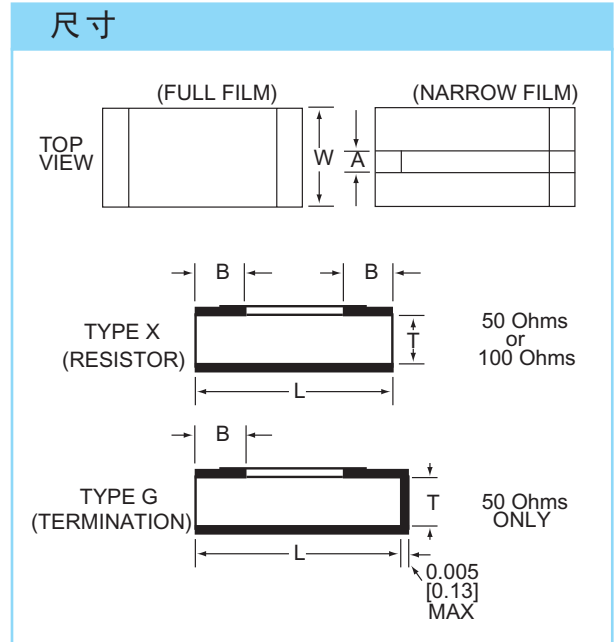

参数列表

Model Name	W In [mm]	L In [mm]	T In [mm]	A In [mm]	B In [mm]	Frequency (Ghz)	Cap. (pf)	VSWR (Typ.)	Power (Max.)
MANC100200T050G	.100 [2.5]	.200 [5.1]	.040 [1.02]			DC-4.0	1.0	1.15	10W
MANC120160T050G	.120 [3.0]	.160 [4.0]	.040 [1.02]			DC-4.0	1.2	1.15	10W
MANC160160T050G	.160 [4.0]	.160 [4.0]	.040 [1.02]			DC-4.0	1.2	1.15	20W
MANC250250T050G	.250 [6.4]	.250 [6.4]	.040 [1.02]			DC-3.0	1.5	1.25	50W
MANC350225T050G	.350 [8.9]	.225 [5.7]	.040 [1.02]	.045 [1.14]	.050 [1.27]	DC-3.0	1.4	1.15	100W
MANC250375T050G	.250 [6.4]	.375 [9.5]	.040 [1.02]		.050 [1.27]	DC-2.0	4.5	1.25	150W
MANC375375T050G	.375 [9.5]	.375 [9.5]	.040 [1.02]	.120 [3.0]	.080 [2.03]	DC-1.0	4.5	1.25	200W
MANC500500T050G	.500 [12.7]	.500 [12.7]	.040 [1.02]	.120 [3.0]	.080 [2.03]	DC-0.5	7.0	1.25	400W
MANC10001000T050G	1.0 [25.4]	1.0 [25.4]	.060 [1.52]	.250 [6.4]	.080 [2.03]	DC-0.5	15.0	1.25	600W

其他尺寸和参数值可定制.

更多更详细的产品规格参数请参阅我们的网站 [Http://www.rf-power.com.cn](http://www.rf-power.com.cn)

中田电子(深圳)有限公司

CENTRON ELECTRONIC(SHENZHEN) CO.,LTD.

深圳市福田区车公庙泰然工业区苍松大厦北座1602

Add: 1602#, North tower, Cangsong Bldg. chegongmiao. Futian, Shenzhen

Tel: 0755-83846776

Fax: 0755-83846775

[Http://www.rf-power.com.cn](http://www.rf-power.com.cn)

E-mail: milcom@milcom.com.cn



产品应用

本系列片式产品需安装在合适的散热器上, 可用于功率分配网络中的终端负载和平衡电阻。薄膜电阻技术和激光调阻技术保证了产品在大功率下的可靠性及产品精度等性能。其氮化铝基板和无铅工艺可用于那些对氧化铍材料有限制或需符合欧盟RoHS指令的地方。

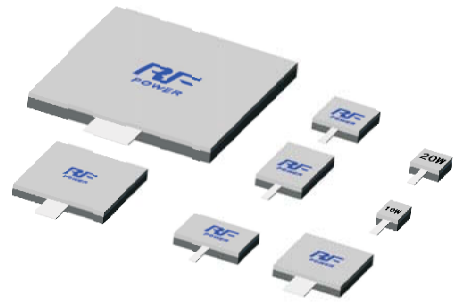

产品订货编号

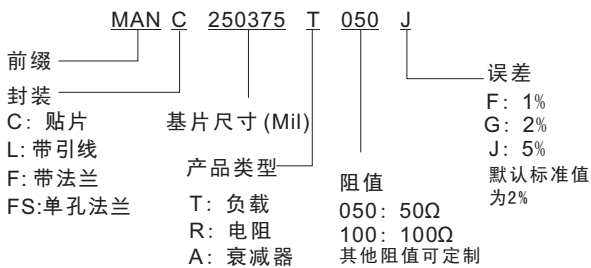

基本参数

引线	铜表面镀锡, 镀银或镀金
基板	氮化铝 (ALN)
盖板	96%氧化铝

尺寸

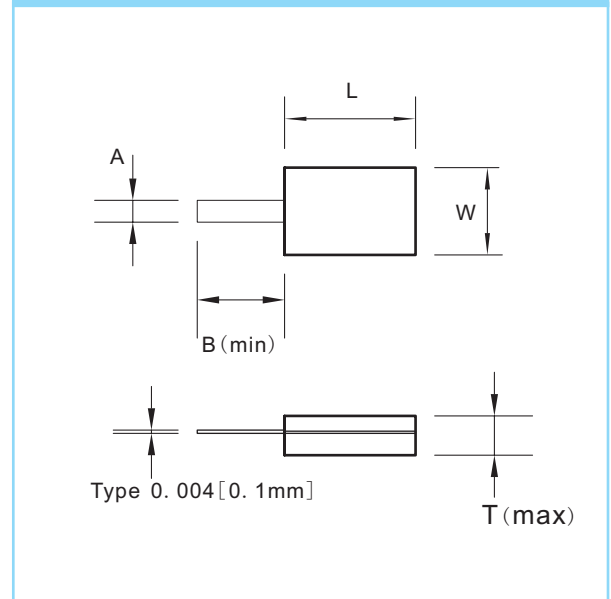

参数列表

Model Name	W In [mm]	L In [mm]	T(max) In [mm]	A In [mm]	B(min) In [mm]	Frequency (Ghz)	VSWR (Typ.)	Power (Max.)
MANL100200T050G	.100 [2.5]	.200 [5.1]	.075 [1.90]	.040 [1.02]	.160 [4.0]	DC-4.0	1.15	10W
MANL120160T050G	.120 [3.0]	.160 [4.0]	.075 [1.90]	.040 [1.02]	.160 [4.0]	DC-4.0	1.15	10W
MANL160160T050G	.160 [4.0]	.160 [4.0]	.075 [1.90]	.040 [1.02]	.160 [4.0]	DC-4.0	1.15	20W
MANL250250T050G	.250 [6.4]	.250 [6.4]	.075 [1.90]	.040 [1.02]	.160 [4.0]	DC-3.0	1.25	50W
MANL350225T050G	.350 [8.9]	.225 [5.7]	.075 [1.90]	.040 [1.02]	.160 [4.0]	DC-3.0	1.15	100W
MANL250375T050G	.250 [6.4]	.375 [9.5]	.075 [1.90]	.040 [1.02]	.160 [4.0]	DC-2.0	1.25	150W
MANL375375T050G	.375 [9.5]	.375 [9.5]	.075 [1.90]	.120 [3.0]	.160 [4.0]	DC-1.0	1.25	200W
MANL500500T050G	.500 [12.7]	.500 [12.7]	.075 [1.90]	.120 [3.0]	.160 [4.0]	DC-0.5	1.25	400W
MANL10001000T050G	1.0 [25.4]	1.0 [25.4]	.060 [1.52]	.250 [6.4]	.160 [4.0]	DC-0.5	1.25	600W

其他尺寸和参数值可定制。

中田电子(深圳)有限公司

CENTRON ELECTRONIC(SHENZHEN) CO.,LTD.

深圳市福田区车公庙泰然工业区苍松大厦北座1602

Add: 1602#. North tower, Cangsong Bldg. chegongmiao. Futian, Shenzhen

Tel: 0755-83846776

Fax: 0755-83846775

Http://www.rf-power.com.cn

E-mail: milcom@milcom.com.cn



产品应用

本系列产品需安装在合适的散热器上, 可用于功率分配网络中的终端负载和平衡电阻. 在提供满负荷功率耗散时也很低的驻波比.



产品订货编号

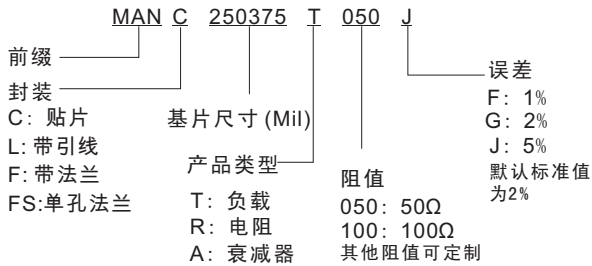

基本参数

电阻	薄膜
引线	铜表面镀锡, 镀银或镀金
基板	氮化铝 (ALN)
法兰	铜, 表面镀镍

功率-温度曲线

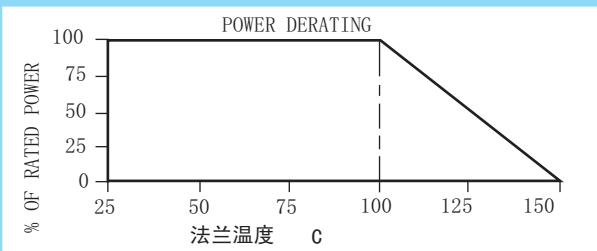

结构尺寸

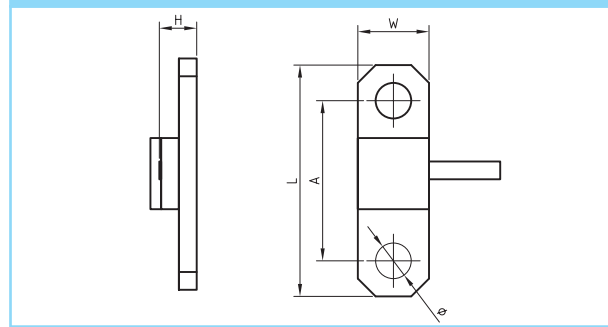

Model Name	W In [mm]	L In [mm]	H(max) In [mm]	A In [mm]	Φ In [mm]	Frequency (Ghz)	VSWR (Typ.)	Power (Max.)
MANFS100200T050G	.200 [5.1]	.300 [7.6]	.110 [2.79]		.116 [2.95]	DC-4.0	1.15	10W
MANFS120160T050G	.160 [4.0]	.295 [7.5]	.090 [2.29]		.100 [2.5]	DC-4.0	1.15	10W
MANF120160T050G	.160 [4.0]	.510 [13.0]	.090 [2.29]	.354 [9.0]	.080 [2.0]	DC-4.0	1.15	10W
MANFS160160T050G	.160 [4.0]	.330 [8.4]	.080 [2.0]		.090 [2.29]	DC-4.0	1.15	20W
MANF160160T050G	.160 [4.0]	.510 [13.0]	.090 [2.29]	.354 [9.0]	.080 [2.0]	DC-4.0	1.15	20W
MANFS250250T050G	.250 [6.4]	.500 [12.7]	.110 [2.79]		.116 [2.95]	DC-3.0	1.25	50W
MANF350225T050G-1	.236 [6.0]	.630 [16.0]	.070 [1.78]	.510 [13.0]	.130 [3.3]	DC-3.0	1.15	100W
MANF350225T050G-2	.230 [5.7]	.800 [20.3]	.110 [2.79]	.560 [14.2]	.130 [3.3]	DC-3.0	1.15	100W
MANF250375T050G	.375 [9.5]	.870 [22.1]	.110 [2.79]	.560 [14.2]	.160 [4.0]	DC-2.0	1.25	150W
MANF375375T050G	.375 [9.5]	.975 [24.8]	.171 [4.3]	.725 [18.4]	.125 [3.17]	DC-1.0	1.25	200W
MANF500500T050G	.500 [12.7]	1.25 [31.8]	.171 [4.3]	.871 [22.2]	.160 [4.0]	DC-0.5	1.25	400W
MANF10001000T050G	1.04 [26.4]	1.9 [48.26]	.195 [4.95]	1.55 [39.37]	.166 [4.22]	DC-0.5	1.25	600W

其他尺寸和参数值可定制.

中田电子(深圳)有限公司

CENTRON ELECTRONIC(SHENZHEN) CO.,LTD.

深圳市福田区车公庙泰然工业区苍松大厦北座1602

Add: 1602#, North tower, Cangsong Bldg. chegongmiao. Futian, Shenzhen

Tel: 0755-83846776

Fax: 0755-83846775

Http://www.rf-power.com.cn



E-mail: milcom@milcom.com.cn



带法兰电阻和负载

大功率, 氮化铝 (ALN) 基板, 薄膜技术, 10W-600W

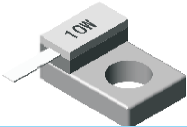
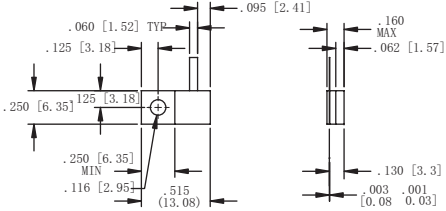
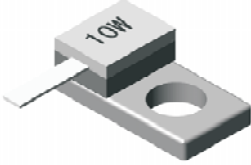
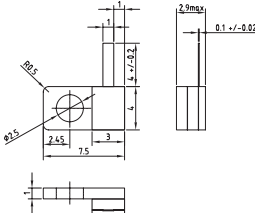
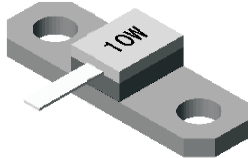
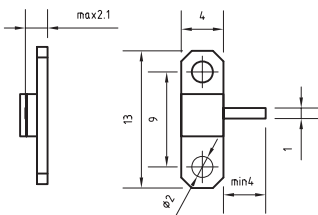

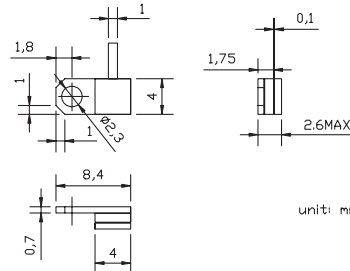
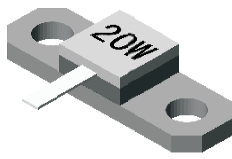
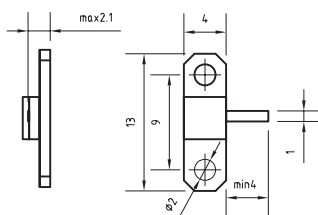
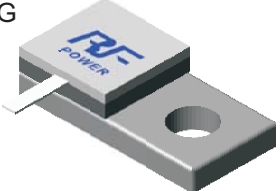
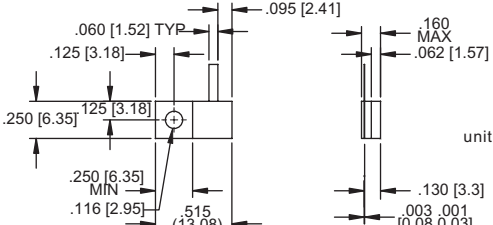
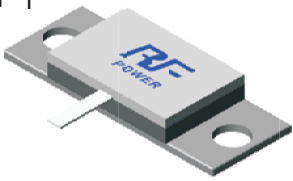
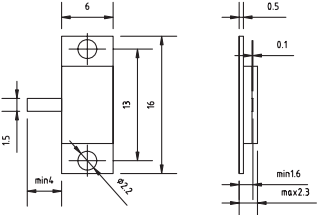
<p>MANFS100200T050G</p> 	
<p>MANFS120160T050G</p> 	 <p style="text-align: right;">Unit: mm</p>
<p>MANF120160T050G</p> 	 <p style="text-align: right;">unit:mm</p>
<p>MANFS160160T050G</p> 	 <p style="text-align: right;">unit: mm</p>
<p>MANF160160T050G</p> 	 <p style="text-align: right;">unit:mm</p>
<p>MANFS250250T050G</p> 	 <p style="text-align: right;">unit: inch (mm)</p>
<p>MANF350225T050G-1</p> 	 <p style="text-align: right;">unit: mm</p>

中田电子(深圳)有限公司

CENTRON ELECTRONIC(SHENZHEN) CO.,LTD.

深圳市福田区车公庙泰然工业区苍松大厦北座1602

Add: 1602#. North tower, Cangsong Bldg. chegongmiao. Futian, Shenzhen

Tel: 0755-83846776

Http://www.rf-power.com.cn

Fax: 0755-83846775







E-mail: milcom@milcom.com.cn

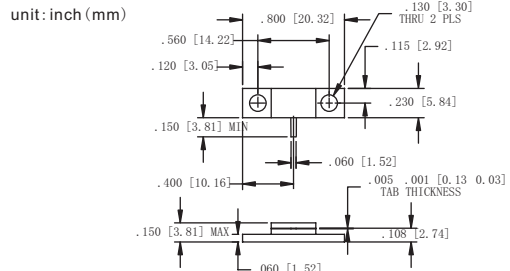

带法兰电阻和负载

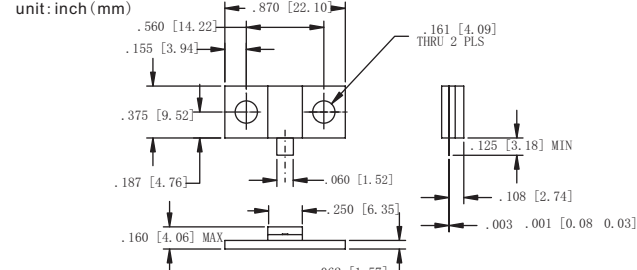
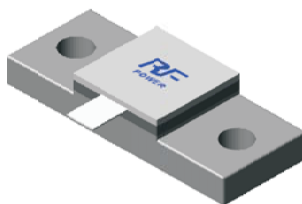
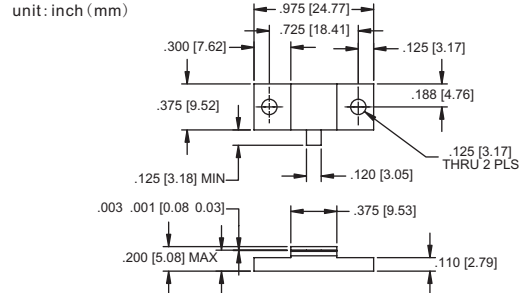

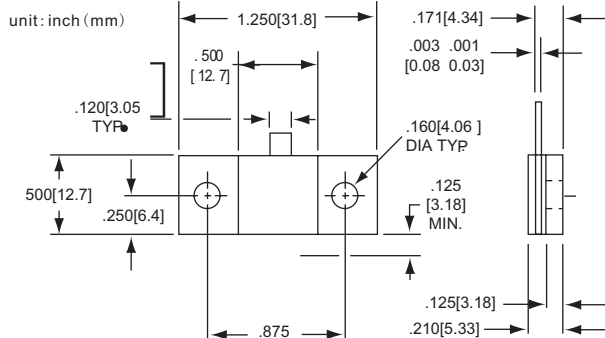
大功率, 氮化铝 (ALN) 基板, 薄膜技术, 10W-600W

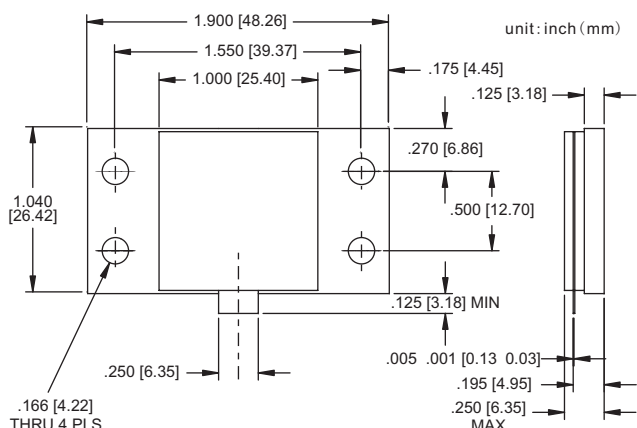
<p>MANF350225T050G-2</p> 	<p>unit: inch (mm)</p> 
<p>MANF250375T050G</p> 	<p>unit: inch (mm)</p> 
<p>MANF375375T050G</p> 	<p>unit: inch (mm)</p> 
<p>MANF500500T050G</p> 	<p>unit: inch (mm)</p> 
<p>MANF10001000T050G</p> 	<p>unit: inch (mm)</p> 

中田电子(深圳)有限公司

深圳市福田区车公庙泰然工业区苍松大厦北座1602

CENTRON ELECTRONIC(SHENZHEN) CO.,LTD.

Address: 1602#, North tower, Cangsong Bldg. chegongmiao. Futian, Shenzhen

Tel: 0755-83846776

Fax: 0755-83846775

Http://www.rf-power.com.cn

E-mail: milcom@milcom.com.cn

